

Article number: 03505040

Description: Fluro Rod end GE 40FO

Measures

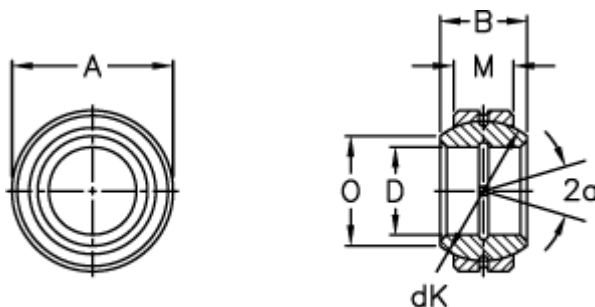

Str. 6–12 uden smørerille

A	= 68 0 -0,013	Tilt angle = 17
B	= 40	Weight = 540
D	= 40 0 -0,012	
dK	= 60	
Dynamic load C (kN)	= 127	
M	= 25	
O	= 44.7	
Static load C0 (kN)	= 640	